

■ Package Dimension:

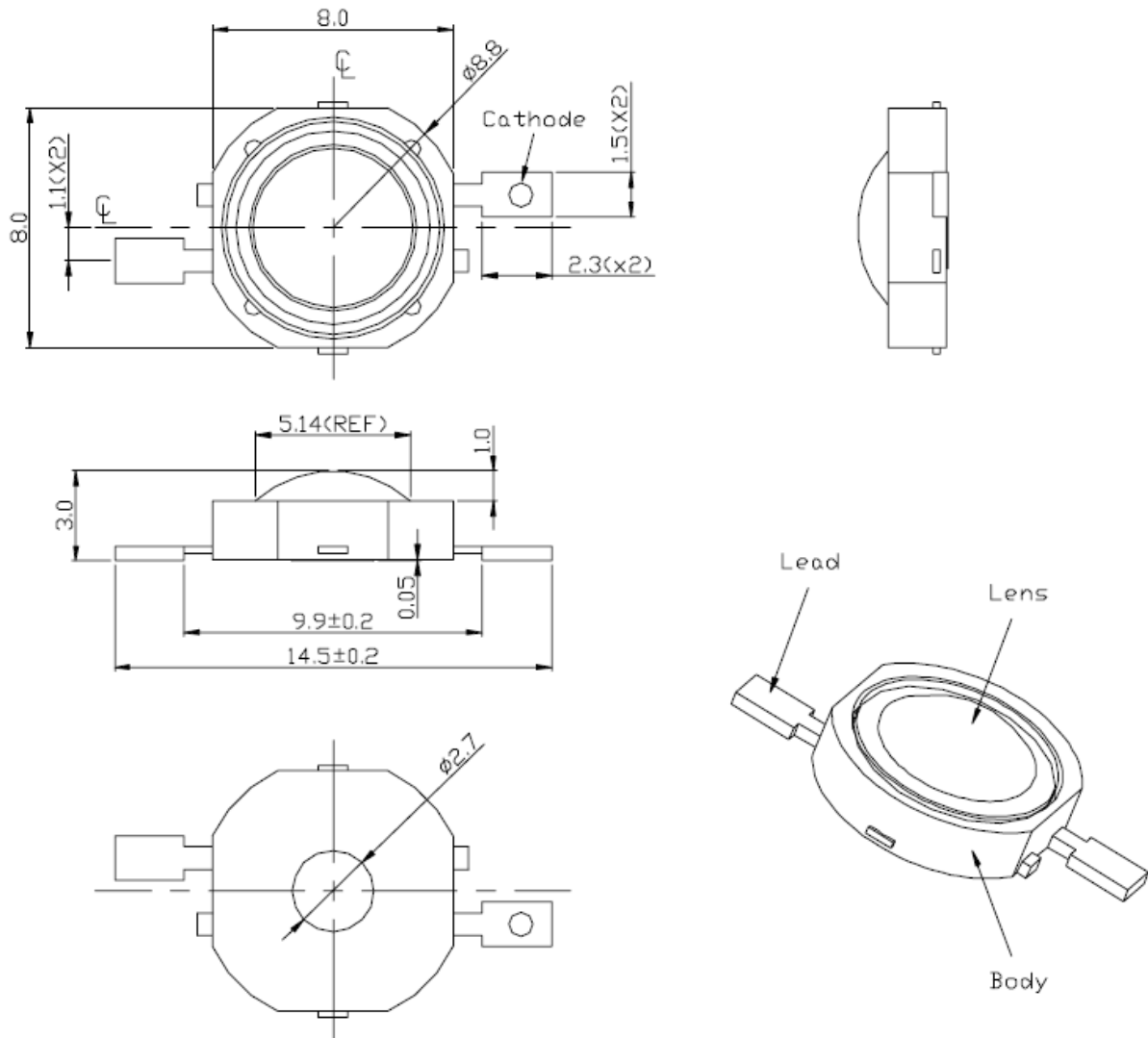

Part NO.	Housing	Emitting Color	Lens Color
AL-508R5WC	----	Red	Water Clear

Notes:

1. All dimensions are in millimeters (inches).
2. Tolerance is $\pm 0.25\text{mm}$ (.010") unless otherwise noted.
3. Protruded resin under flange is 1.0mm(.04") max.
4. Lead spacing is measured where the leads emerge from the package.
5. Specifications are subject to change without notice.
6. This data-sheet only valid for six months.

■ Absolute Maximum Ratings at Ta=25°C

Parameter	Symbol	MAX.	Unit
DC Forward Current	I _F	770	mA
Peak pulsed forward current	---	1100	mA
Average forward current	---	700	mA
ESD Sensitivity	---	± 16000	V HBM
LED junction Temperature (at 350mA)	T _j	120	°C
Operating Temperature Range	Topr	-40 to +105	°C
Storage Temperature Range	Tstg	-40 to +105	°C
Aluminum-core PCB Temperature	---	105	°C
Soldering Temperature (Max.)	Tsol	260 ± 5	seconds

■ Electrical Optical Characteristics at Ta=25°C

Parameter	Symbol	Min.	Typ.	Max.	Unit	Test Condition
Luminous Flux	Flux	87.4	125	---	Im	I _F =700mA
Forward Voltage	V _F	3.75	4.40	6.20	V	I _F =700mA
Wavelength	λ d	620.5	625	645	nm	I _F =700mA
Spectral Half-Width	Δ λ 1/2	---	20	---	nm	I _F =700mA
Temperature Coefficient or Dominant Wavelength	Δ λ d / Δ Tj	---	0.05	---	nm/°C	I _F =700mA
Temperature Coefficient of V _F	Δ V _F / Δ Tj	---	-4	---	mV/°C	I _F =700mA
Thermal Resistance Junction to Board	----	---	8	---	°C/W	I _F =700mA
Dynamic Resistance	----	---	2.4	---	Ω	I _F =700mA
Total Included Angle	θ0.9v	---	160	---	Deg	I _F =700mA
Viewing Angle	2θ1/2	---	140	---	Deg	I _F =700mA

Wavelength Characteristics, $T_j=25^\circ\text{C}$

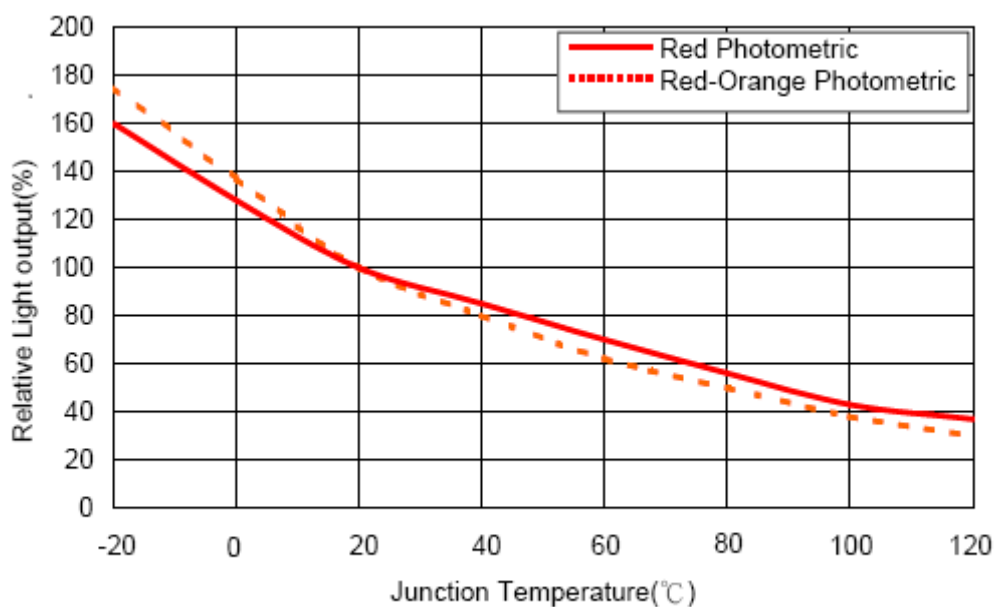
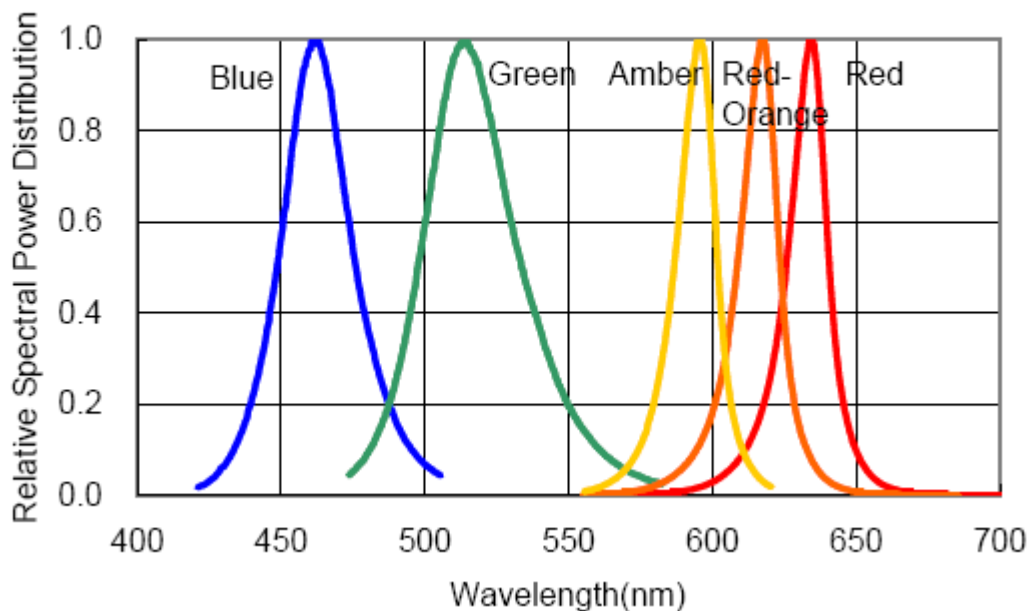
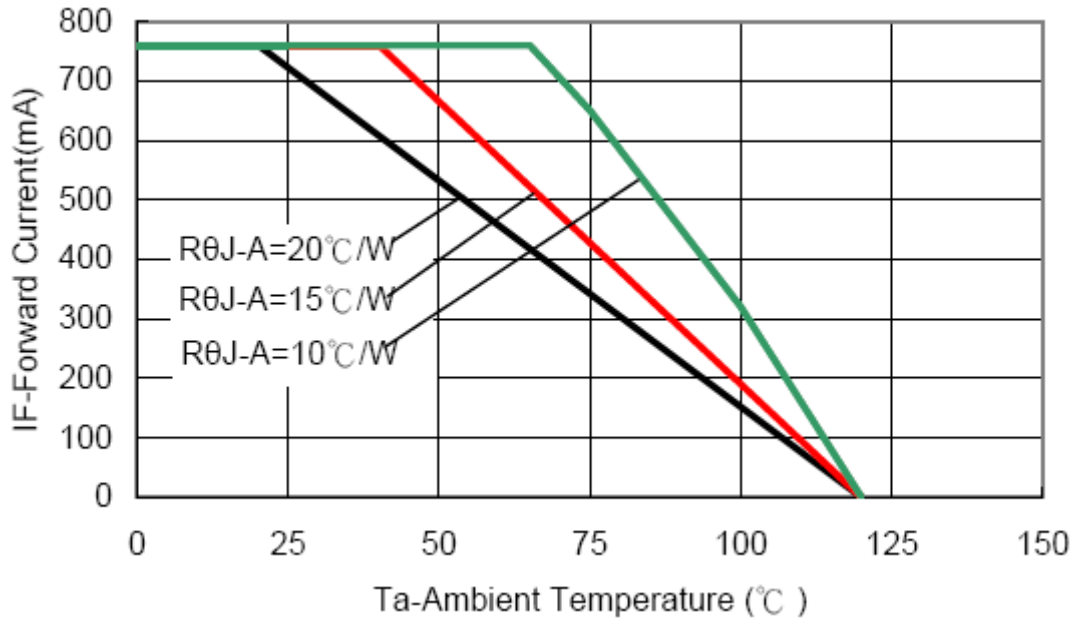
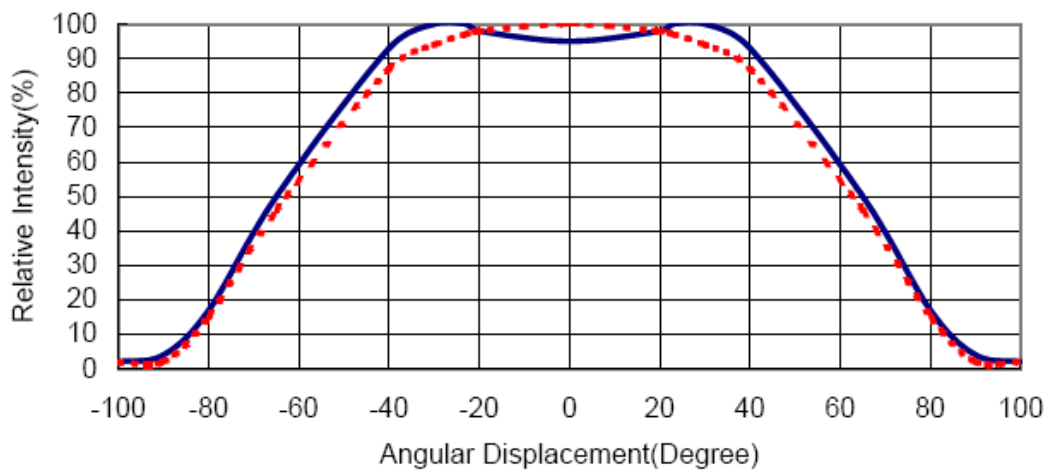

Figure 2b. Relative Light Output vs. Junction Temperature



Typical Representative Spatial Radiation Pattern
Lambertian Radiation Pattern



Forward Current Characteristics, $T_j=25^\circ\text{C}$

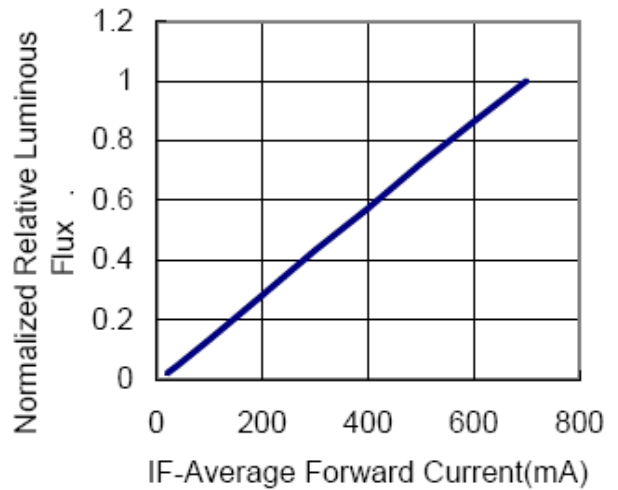
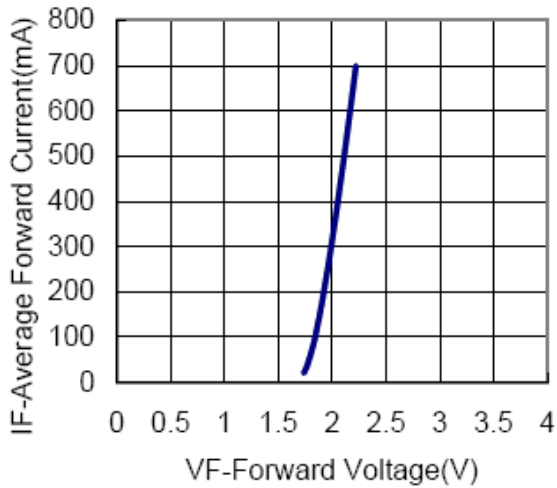

Temperature-profile (Surface of MCPCB)

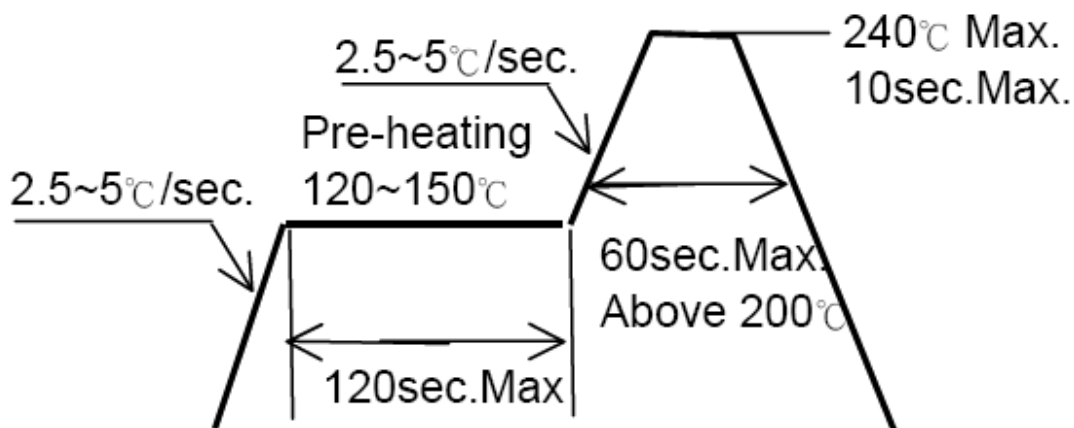

Emitter Reel Packaging

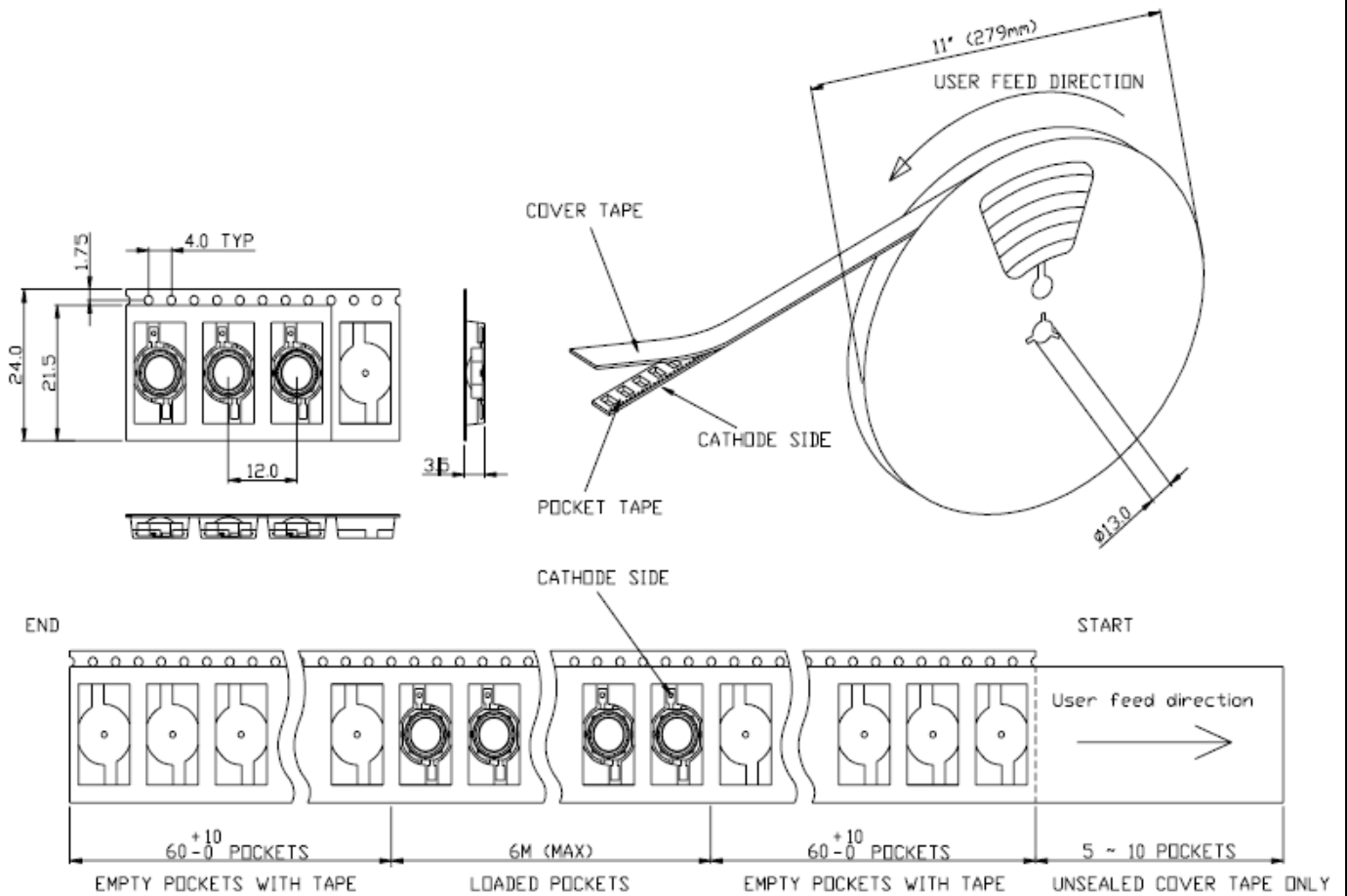

Notes:

1. The emitters should be picked up by the body (not the lens) during placement. The inner diameter of the pick-up collet should be greater than or equal to 6.5 mm.
2. Drawing not to scale.
3. All dimensions are in millimeters.
4. All dimensions without tolerances are for reference only.