

■ Package Dimension:

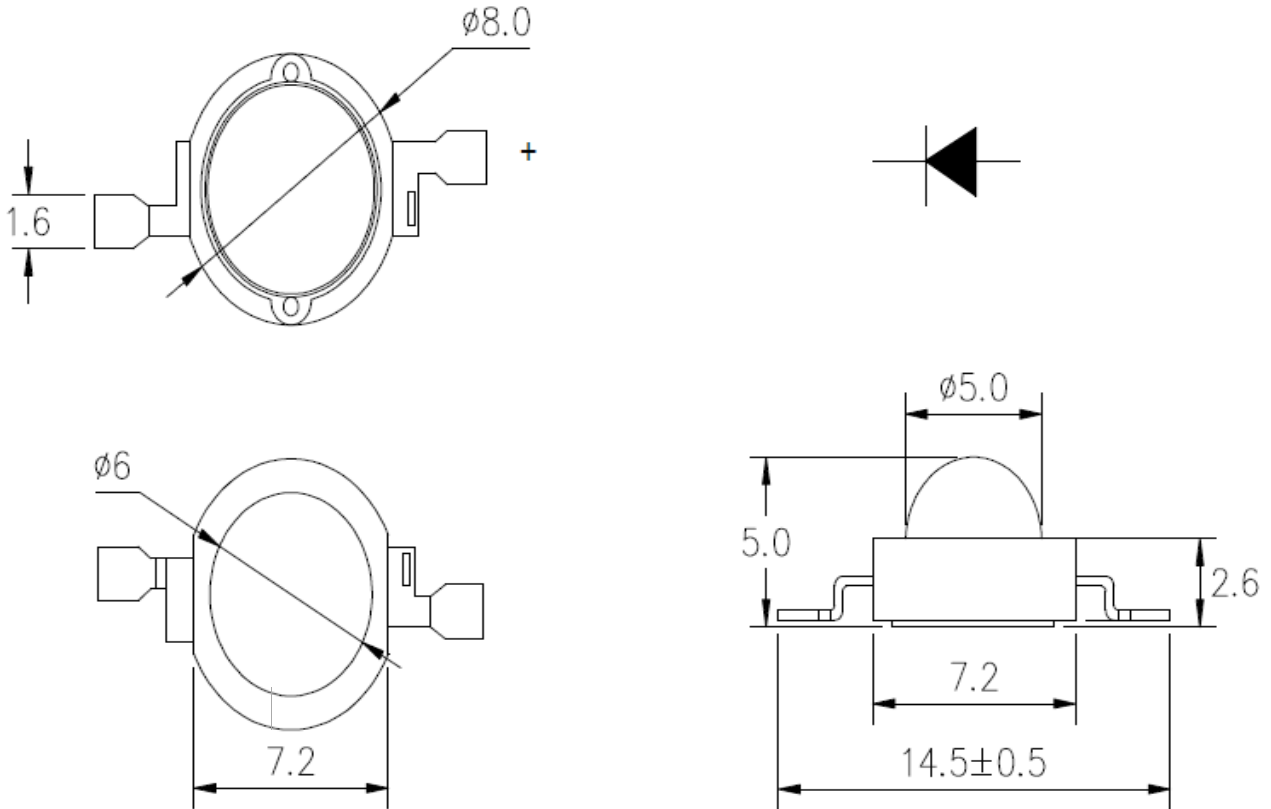

Part NO.	Chip	Emitting Color	Lens Color
AL-01R5IR1WC-A20	AlGaAs	Infrared	Water Clear

Notes:

1. All dimensions are in millimeters (inches).
2. Tolerance is $\pm 0.25\text{mm}$ (.010") unless otherwise noted.
3. Protruded resin under flange is 1.0mm(.04") max.
4. Lead spacing is measured where the leads emerge from the package.
5. Specifications are subject to change without notice.
6. This data-sheet only valid for six months.

■ Absolute Maximum Ratings at Ta=25°C

Parameter	Symbol	MAX.	Unit
DC Forward Current	I _F	700	mA
Reverse Voltage	V _R	5	V
Power Dissipation	P _D	1.5	W
Electrostatics discharge	ESD	8000	V
Operating Temperature Range	Topr	-20 to +80	°C
Storage Temperature Range	Tstg	-20 to +80	°C
Manual Soldering Time at 260°C (Max.)	Tsol	5	seconds

■ Electrical Optical Characteristics at Ta=25°C

Parameter	Symbol	Min.	Typ.	Max.	Unit	Test Condition
Radiated Output Power	P _O	300	390	---	mW/sr	I _F =700mA
Forward Voltage	V _F	1.4	1.8	2.5	V	I _F =700mA
Peak Wavelength	λ _p	---	850	---	nm	I _F =700mA
Spectral Bandwidth	△λ	---	30	---	nm	I _F =700mA
Reverse Current	I _R	---	---	10	μA	I _F =700mA
Emission Angle	2θ _{1/2}	---	120	---	Deg	I _F =700mA

■ Characteristics Curves $T_J=25^\circ\text{C}$

Fig.1 Forward current vs. Forward voltage

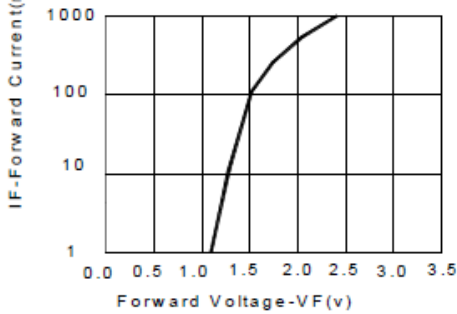

Fig.2 Relative intensity vs. Wavelength

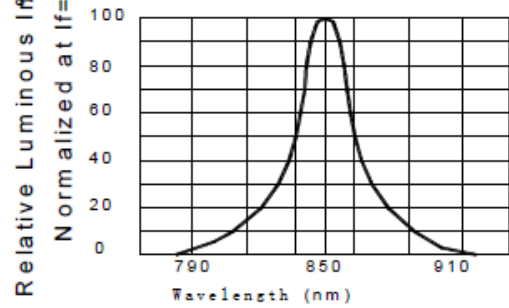

Fig.3 Relative Radiant Flux vs. Forward current

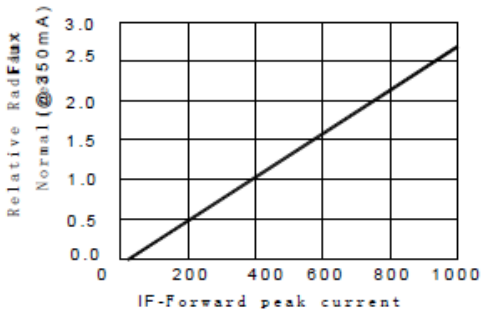

Fig.4 Forward Voltage (@ 350mA) vs Ambient temperature

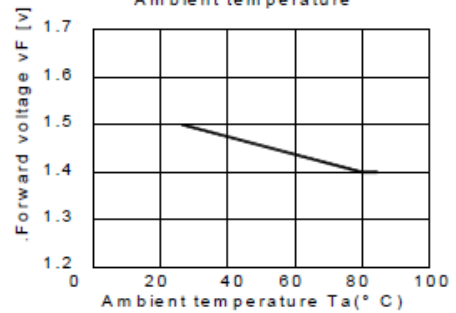

Fig.5 Relative Radiant Flux (@ 350mA) vs. Ambient temperature

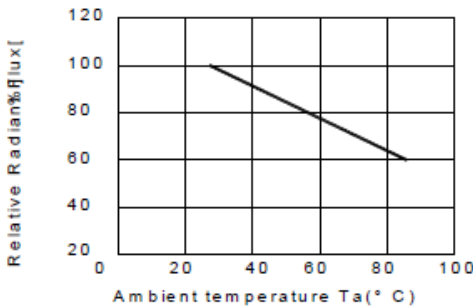

Fig.6 Maximum Driving Forward DC Current vs. Ambient Temperature (Derating based on T_J max.=115°C)

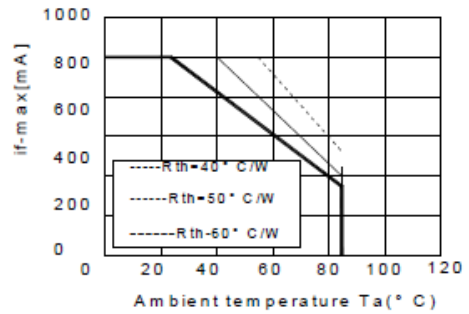
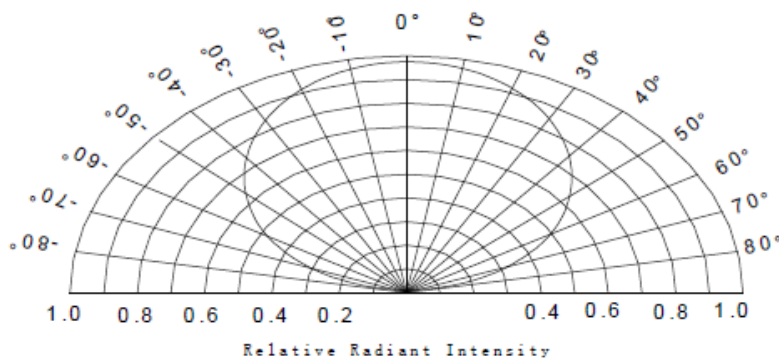

Fig.7 Radiation diagram



■ Reliability Test Item and Condition:

The reliability of products shall be satisfied with items listed below.

Confidence level : 90%

LTPD : 10%

NO.	Item	Test Conditions	Test Hours/ Cycles	Sample Sizes	Failure Judgement Criteria	Ac/Re
1	REFLOW Soldering	TEMP. : 260°C±5°C 10secs	6Mins	22pcs	$I_R \geq U \times 2$	0/1
2	Temperature Cycle	H : +100°C 15mins ↕ 5mins L : -40°C 15mins	300Cycles	22pcs	$I_e \leq L \times 0.8$ $V_F \geq U \times 1.2$	0/1
3	Thermal Shock	H : +100°C 5mins ↕ 10secs L : -10°C 5mins	300Cycles	22pcs	U : Upper Specification Limit	0/1
4	High Temperature Storage	TEMP. : +100°C	1000hrs	22pcs	L : Lower Specification Limit	0/1
5	Low Temperature Storage	TEMP. : -40°C	1000hrs	22pcs		0/1
6	DC Operating Life	$I_F = 700\text{mA}$	1000hrs	22pcs		0/1
7	High Temperature/ High Humidity	85°C / 85% R.H	1000hrs	22pcs		0/1