

A-BRIGHT A-BRIGHT INDUSTRIAL CO., LTD. SURFACE MOUNT LED LAMPS

Power White Surface Mount Device

Part Number: 62-217AUW2C2H

Package outlines & Re-flow Profile

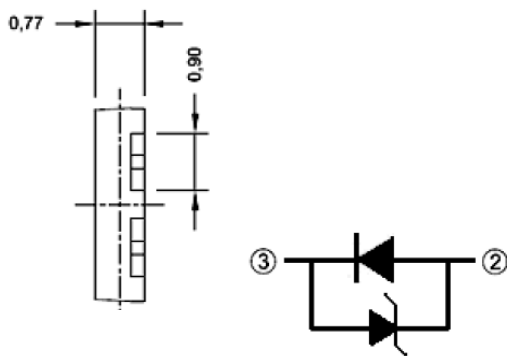
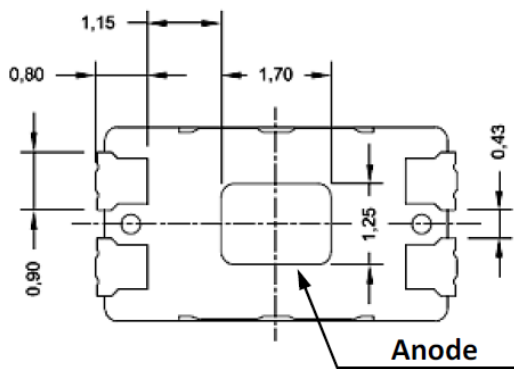
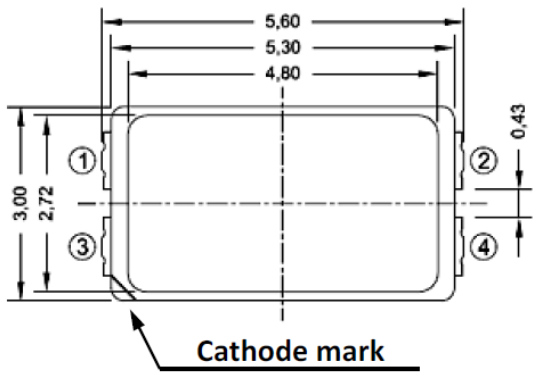

For Reflow Soldering

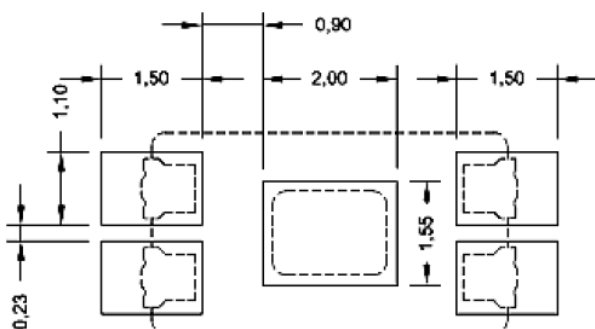

Reflow Temp/Time

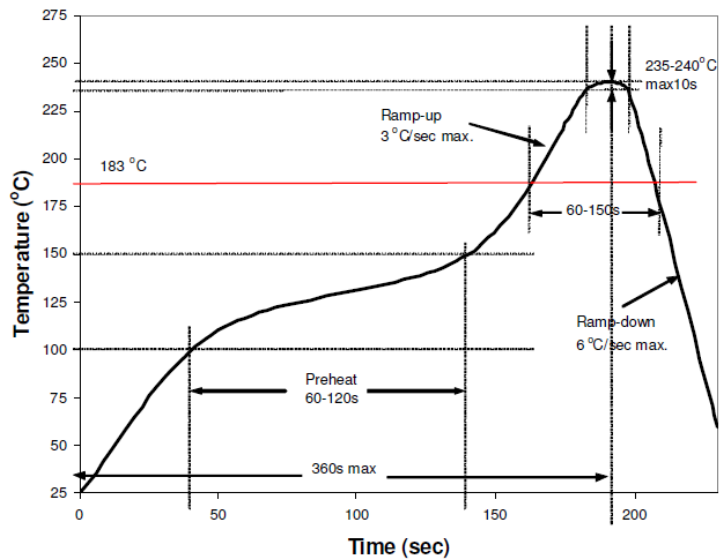

Soldering iron

Basic spec is ≤ 5 sec when 260°C . If temperature is higher, time should be shorter ($+10^{\circ}\text{C} \rightarrow -1$ sec). Power dissipation of iron should be smaller than 15W, and temperatures should be controllable. Surface temperature of the device should be under 230°C .

ITEM	MATERIALS
Resin (mold)	Epoxy
Lens color	Yellow Diffused
Printed circuit board	BT
Emitted color	White
Material	InGaN

NOTES:

- All dimensions are in millimeters (inches);
- Tolerances are ± 0.1 mm (0.004inch) unless otherwise noted.
- Polarity referring onto the cathode mark is reversed on the red.

A-BRIGHT A-BRIGHT INDUSTRIAL CO., LTD.
SURFACE MOUNT LED LAMPS

Part Number: 62-217AUW2C2H

ELECTRO-OPTICAL CHARACTERISTICS (T_A=25°C)

Parameter	Test Condition	Symbol	Value			Unit
			MIN.	TYP.	MAX.	
Viewing angle at 50% I _v	I _F =120mA	2θ 1/2	120			Deg
Forward voltage	I _F =120mA	V _F	2.9	3.1	3.6	V
Correlated Color Temperature	I _F =120mA	CCT	3700	---	7000	K
Color Rendering Index	I _F =120mA	CRI	---	80	---	---
Pulse Forward Current (Pulse Width ≤ 10msec, and duty ≤ 1/10)	I _F =120mA	I _{FP}	360			mA

Absolute maximum ratings (T_A=25°C)

Parameter	Symbol	Value	Unit
Forward current	I _F	180	mA
Reverse voltage	V _R	5	V
Power dissipation	P _D	0.65	W
Operating temperature range	Top	-40 ~+85	°C
Storage temperature range	Tstg	-40 ~+100	°C

A-BRIGHT A-BRIGHT INDUSTRIAL CO., LTD.
SURFACE MOUNT LED LAMPS

Part Number: 62-217AUW2C2H

Bin Range

V _F Rank	Condition	Min.	Max.
1	I _F = 120 mA	2.9	3.0
2		3.0	3.1
3		3.1	3.2
4		3.2	3.3
5		3.3	3.4
6		3.4	3.5
7		3.5	3.6
Luminous Flux Rank	Condition	Min.	Max.
VI	I _F = 120 mA	36	40.5
VJ		40.5	45
VK		45	49.5
VL		49.5	54

A-BRIGHT A-BRIGHT INDUSTRIAL CO., LTD.
SURFACE MOUNT LED LAMPS

Part Number: 62-217AUW2C2H

Bin Range

4000K					
Rank	CIE X	CIE Y	Rank	CIE X	CIE Y
K401	0.4006	0.4044	M401	0.3871	0.3959
	0.3939	0.4002		0.3804	0.3917
	0.3914	0.3922		0.3784	0.3841
	0.3979	0.3962		0.3849	0.3881
K402	0.3979	0.3962	M402	0.3849	0.3881
	0.3914	0.3922		0.3784	0.3841
	0.3890	0.3842		0.3765	0.3765
	0.3952	0.3880		0.3828	0.3803
K403	0.3952	0.3880	M403	0.3828	0.3803
	0.3890	0.3842		0.3765	0.3765
	0.3865	0.3762		0.3746	0.3689
	0.3925	0.3798		0.3806	0.3725
K404	0.3925	0.3798	M404	0.3806	0.3725
	0.3865	0.3762		0.3746	0.3689
	0.3841	0.3682		0.3727	0.3613
	0.3898	0.3716		0.3784	0.3647
L401	0.3939	0.4002	N401	0.3804	0.3917
	0.3871	0.3959		0.3736	0.3874
	0.3849	0.3881		0.3720	0.3800
	0.3914	0.3922		0.3784	0.3841
L402	0.3914	0.3922	N402	0.3784	0.3841
	0.3849	0.3881		0.3720	0.3800
	0.3828	0.3803		0.3703	0.3726
	0.3890	0.3842		0.3765	0.3765
L403	0.3890	0.3842	N403	0.3765	0.3765
	0.3828	0.3803		0.3703	0.3726
	0.3806	0.3725		0.3687	0.3652
	0.3865	0.3762		0.3746	0.3689
L404	0.3865	0.3762	N404	0.3746	0.3689
	0.3806	0.3725		0.3687	0.3652
	0.3784	0.3647		0.3670	0.3578
	0.3841	0.3682		0.3727	0.3613

A-BRIGHT A-BRIGHT INDUSTRIAL CO., LTD.

SURFACE MOUNT LED LAMPS

Part Number: 62-217AUW2C2H

Bin Range

5000K					
Rank	CIE X	CIE Y	Rank	CIE X	CIE Y
G502	0.3376	0.3616	H502	0.3463	0.3687
	0.3373	0.3534		0.3456	0.3601
	0.3456	0.3601		0.3539	0.3669
	0.3463	0.3687		0.3552	0.376
G503	0.3373	0.3534	H503	0.3456	0.3601
	0.3369	0.3451		0.3448	0.3514
	0.3448	0.3514		0.3526	0.3578
	0.3456	0.3601		0.3539	0.3669
G504	0.3369	0.3451	H504	0.3448	0.3514
	0.3366	0.3369		0.344	0.3428
	0.344	0.3428		0.3514	0.3487
	0.3448	0.3514		0.3526	0.3578

5700K					
Rank	CIE X	CIE Y	Rank	CIE X	CIE Y
E572	0.3207	0.3462	F572	0.3292	0.3539
	0.3212	0.3389		0.3293	0.3461
	0.3293	0.3461		0.3373	0.3534
	0.3292	0.3539		0.3376	0.3616
E573	0.3212	0.3389	F573	0.3293	0.3461
	0.3217	0.3316		0.3293	0.3384
	0.3293	0.3384		0.3369	0.3451
	0.3293	0.3461		0.3373	0.3534
E574	0.3217	0.3316	F574	0.3293	0.3384
	0.3222	0.3243		0.3294	0.3306
	0.3294	0.3306		0.3366	0.3369
	0.3293	0.3384		0.3369	0.3451

6500K					
Rank	CIE X	CIE Y	Rank	CIE X	CIE Y
B652	0.3041	0.324	C654	0.3119	0.3162
	0.3028	0.3304		0.3108	0.3229
	0.3087	0.3363		0.3162	0.3282
	0.3098	0.3296		0.317	0.3212
B653	0.3055	0.3177	D652	0.3154	0.3352
	0.3041	0.324		0.3146	0.3422
	0.3098	0.3296		0.3205	0.3481
	0.3108	0.3229		0.321	0.3408
B654	0.3068	0.3113	D653	0.3162	0.3282
	0.3055	0.3177		0.3154	0.3352
	0.3108	0.3229		0.321	0.3408
	0.3119	0.3162		0.3216	0.3334
C652	0.3098	0.3296	D654	0.317	0.3212
	0.3087	0.3363		0.3162	0.3282
	0.3146	0.3422		0.3216	0.3334
	0.3154	0.3352		0.3221	0.3261
C653	0.3108	0.3229			
	0.3098	0.3296			
	0.3154	0.3352			
	0.3162	0.3282			

Note:

- (1) Correlated color Temperature is derived from the CIE 1931 Chromaticity diagram
- (2) Measurement tolerance is ± 0.01
- (3) The luminous flux tolerance is $\pm 10\%$
- (4) The Forward Voltage tolerance is $\pm 0.1V$

A-BRIGHT A-BRIGHT INDUSTRIAL CO., LTD. **SURFACE MOUNT LED LAMPS**

Part Number: 62-217AUW2C2H

CIE Chromaticity Diagram

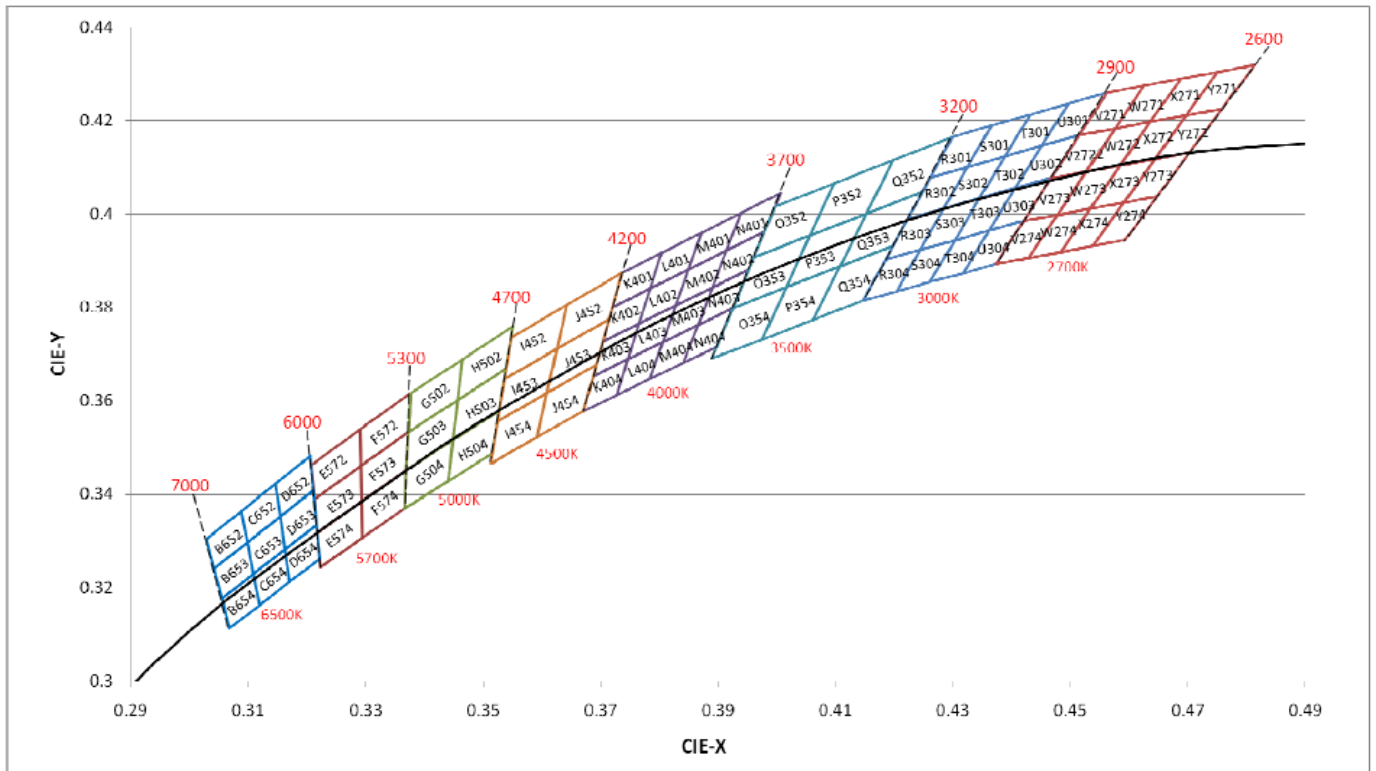

A-BRIGHT A-BRIGHT INDUSTRIAL CO., LTD. SURFACE MOUNT LED LAMPS

Part Number: 62-217AUW2C2H

Typical Electro-Optical Characteristic Curves

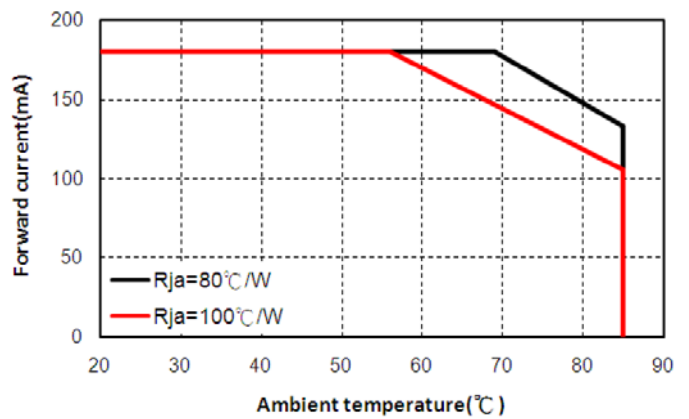
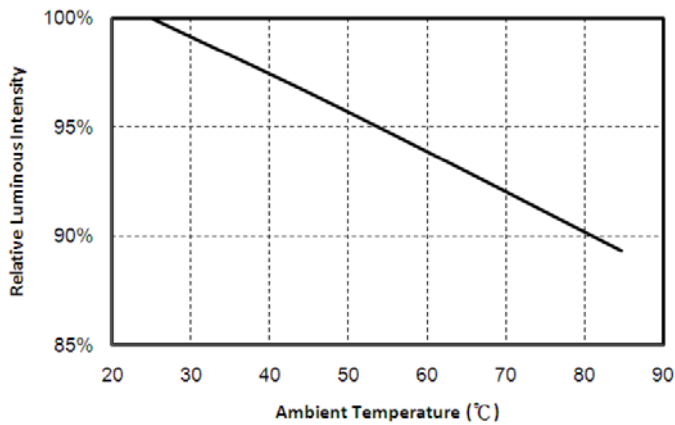
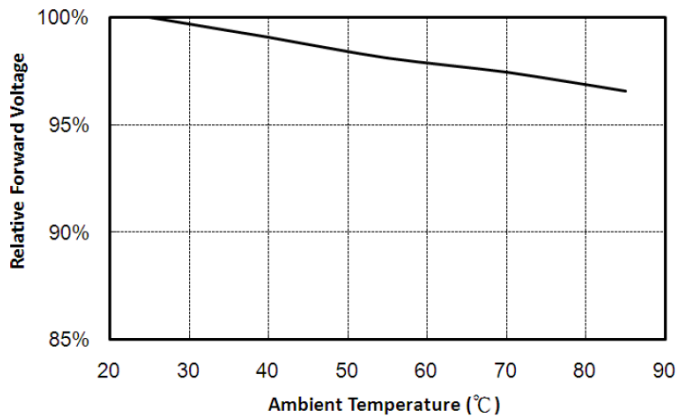
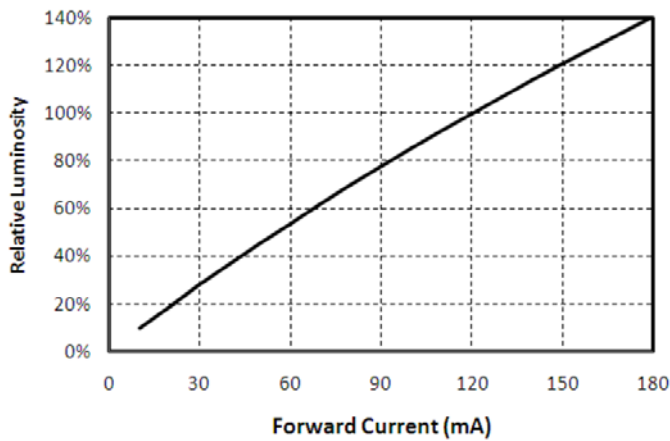
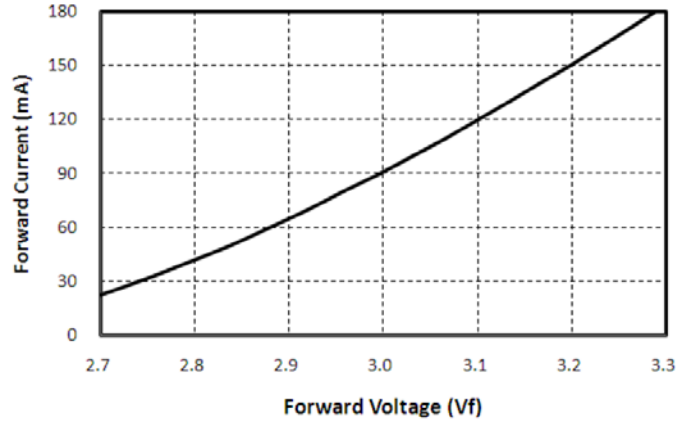
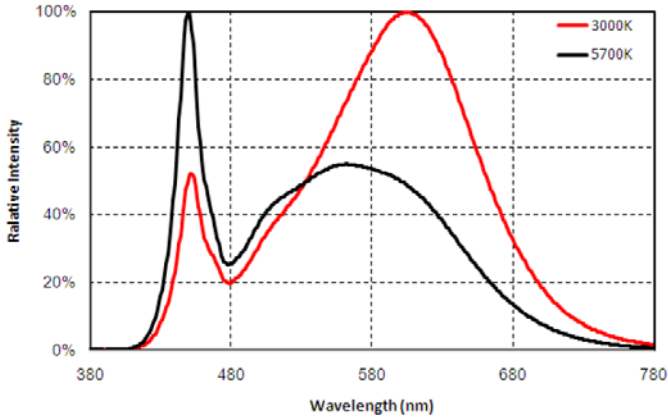

A-BRIGHT A-BRIGHT INDUSTRIAL CO., LTD.
SURFACE MOUNT LED LAMPS

Part Number: 62-217AUW2C2H

Typical Electro-Optical Characteristic Curves

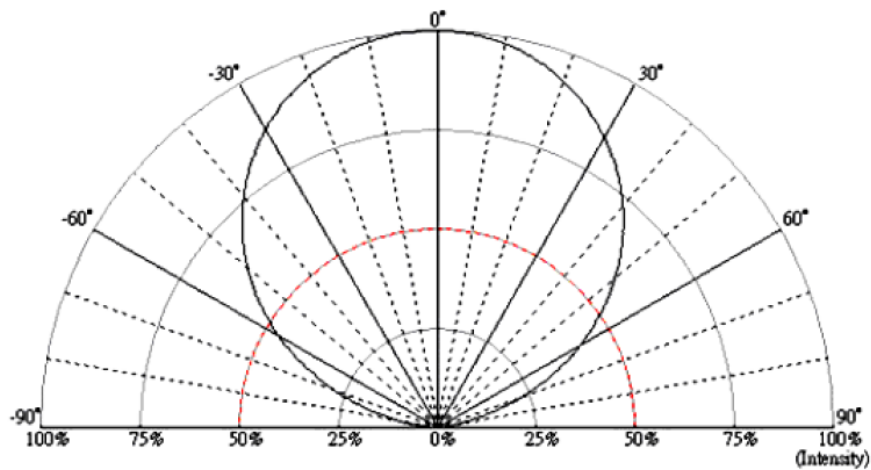
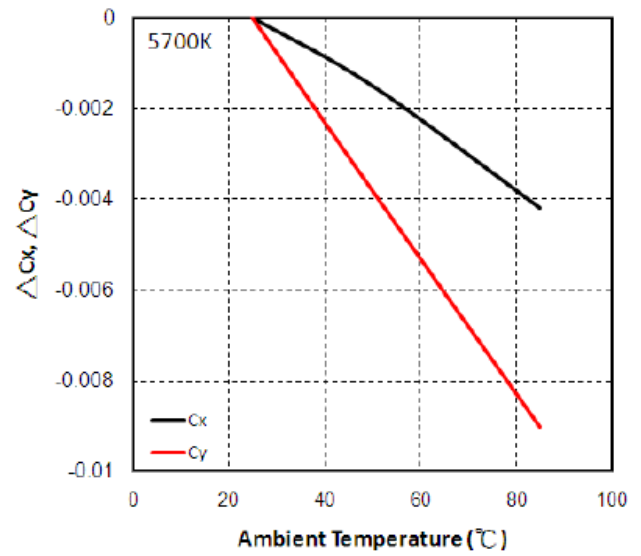
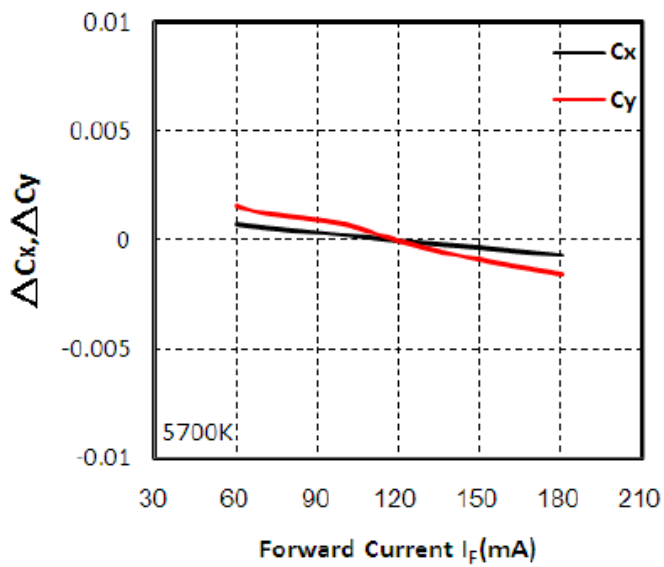

A-BRIGHT A-BRIGHT INDUSTRIAL CO., LTD.
SURFACE MOUNT LED LAMPS

Part Number: 62-217AUW2C2H

Reliability

Item	Condition	Time/Cycle
Steady State Operating Life of Room Temperature	25°C Operating	1000 Hrs
Steady State Operating Life of Low Temperature -40°C	-40°C Operating	1000 Hrs
Steady State Operating Life of High Temperature 60°C	60°C Operating	1000 Hrs
Steady State Operating Life of High Temperature 85°C	85°C Operating	1000 Hrs
Low temperature storage -40°C	-40°C Storage	1000 Hrs
High temperature storage 100°C	100°C Storage	1000 Hrs
Steady State Operating Life of High Humidity Heat 60°C/90%	60°C/90% Operating	1000 Hrs
Steady State Pulse Operating Life Condition	25°C 10Hz duty=1/10 Operating	200 Cycles
Resistance to soldering heat on PCB (JEDEC MSL3)	pre-store@60°C, 60%RH for 52hrs Tslid max.=260°C 10sec	3 Times
Heat Cycle Test (JEDEC MRC)	25°C ~ 65°C ~ -10°C, 90%RH, 24hr/1cycle	10 Cycles
Thermal shock	-40°C/20min ~5min ~ 100°C/20min	300 Cycles

A-BRIGHT A-BRIGHT INDUSTRIAL CO., LTD. SURFACE MOUNT LED LAMPS

Part Number: 62-217AUW2C2H

Package

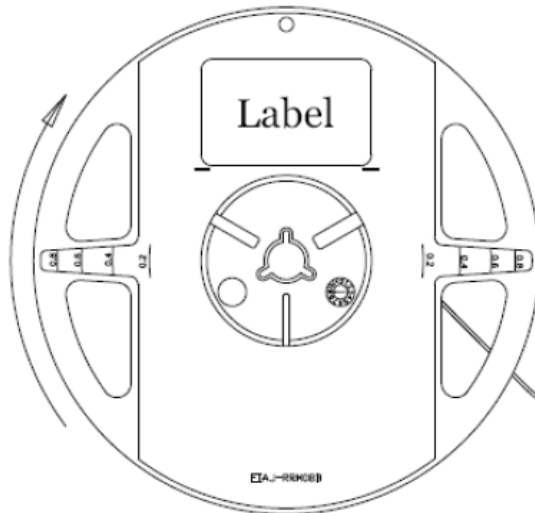

Quantity: 1,000 or 2,000 pcs/reel

Trailer : 400mm · Leader : 200mm

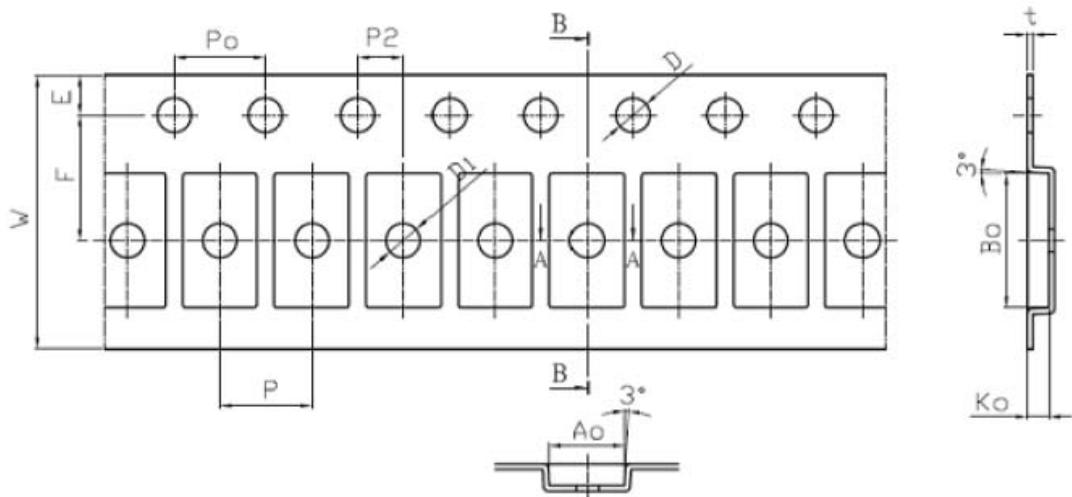
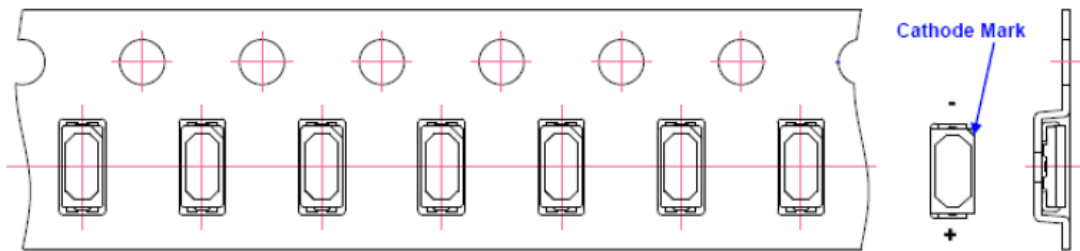
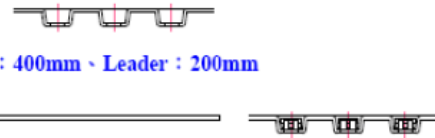

Unit: mm

Item	Spec	To1. (+/-)	Item	Spec	To1. (+/-)
W	12.00	±0.10	P2	2.00	±0.05
E	1.75	±0.10	P0 x 10	40.00	±0.20
F	5.50	±0.05	t1	0.25	±0.05
D	1.50	+0.10, -0.00	A0	3.25	±0.10
D1	1.50	±0.10	B0	5.90	±0.10
P0、P1	4.00	±0.20	K0	0.95	±0.10

A-BRIGHT A-BRIGHT INDUSTRIAL CO., LTD.

SURFACE MOUNT LED LAMPS

Part Number: 62-217AUW2C2H

Precautions For Use

1. Over-current proof

Customer must apply resistors for protection, otherwise slight voltage shift will cause big current change (Burn out will happen).

2. Storage

2.1 Do not open moisture proof bag before the products are ready to use.

2.2 Before opening the package, the LEDs should be kept at 30°C or less and 90%RH or less.

2.3 The LEDs should be used within a year.

2.4 After opening the package, the LEDs should be kept at 30°C or less and 70%RH or less.

2.5 The LEDs should be used within 168 hours (7 days) after opening the package.

2.6 If the moisture absorbent material (silica gel) has faded away or the LEDs have exceeded the storage time, baking treatment should be performed using the following conditions.

Baking treatment : 60±5°C for 24 hours.

3. Soldering Condition

3.1 Pb-free solder temperature profile

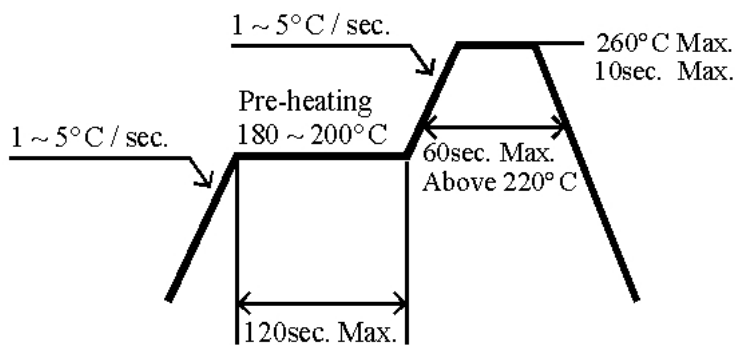

3.2 Reflow soldering should not be done more than two times.

3.3 When soldering, do not put stress on the LEDs during heating.

3.4 After soldering, do not warp the circuit board.

4. Soldering Iron

Each terminal is to go to the tip of soldering iron temperature less than 280°C for 3 seconds within once in less than soldering iron capacity 25W. Leave two seconds and more intervals, and do soldering of each terminal. Be careful because the damage of the product is often started at the time of the hand solder.